

COMPONENT TYPE:

Diesel Connector

CODE:

QCAB – 7.89 Series

Quick-Fit Diesel Connection Systems

System suitable for use with commercial vehicles and passenger cars.

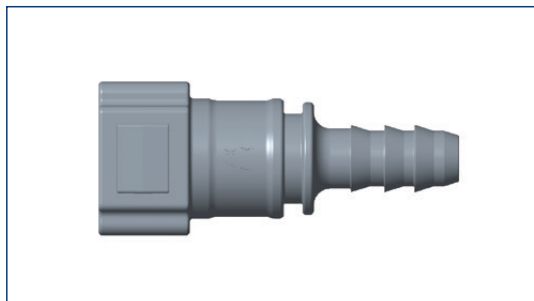

> Standard 7.89mm (5/16") size.

Part Number	Tube Size	Material	Angle	Minimum Order Qty.
QCDF-7.89RA-06	8,0 x 6,0mm	Polyamide 12	90°	10
QCDF-7.89ST-06	8,0 x 6,0mm	Polyamide 12	180°	10
QCDF-7.89RA-08	10,0 x 8,0mm	Polyamide 12	90°	10
QCDF-7.89ST-08	10,0 x 8,0mm	Polyamide 12	180°	10
QCDF-7.89ST-10	12,0 x 9,0mm	Polyamide 12	90°	10
QCDF-7.89RA-10	12,0 x 9,0mm	Polyamide 12	180°	10

Suitable Tubing

> Tube Size – 8,0x6,0mm Compliance – DIN 73378 designated HIPHL

Part Number	Coil Size	Colour	Minimum Order Qty.
NF-0806-25	25 metres	Black	25 metres
NF-0806-100	100 metres	Black	100 metres
NF-0806-250	250 metres	Black	250 metres

> Tube Size – 10,0x8,0mm Compliance – DIN 73378 designated HIPHL

Part Number	Coil Size	Colour	Minimum Order Qty.
NF-1008-25	25 metres	Black	25 metres
NF-1008-100	100 metres	Black	100 metres
NF-1008-250	250 metres	Black	250 metres

> Tube Size – 12,0x9,0mm Compliance – DIN 73378 designated HIPHL

Part Number	Coil Size	Colour	Minimum Order Qty.
NF-1209-25	25 metres	Black	25 metres
NF-1209-100	100 metres	Black	100 metres
NF-1209-250	250 metres	Black	250 metres

Price on application depending on volume.
Working temperature -40 °C to 90 °C