

COMPONENT TYPE: AdBlue Connector

CODE: QCAB – 9.49 Series

Quick-Fit ABlue Connection Systems

System suitable for use with commercial vehicles and passenger cars.

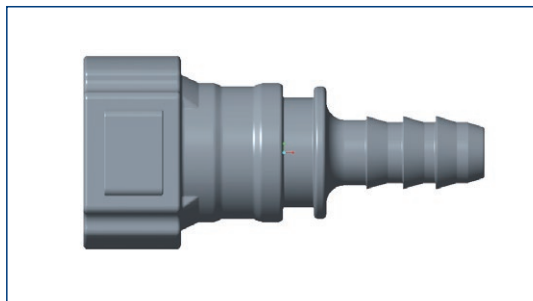
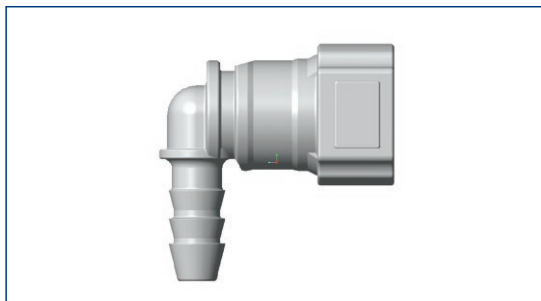

> Standard 9.49mm (3/8") size.

Part Number	Tube Size	Material	Angle	Minimum Order Qty.
QCAB-9.49RA-04	6,0 x 4,0mm	Polyamide 12	90°	10
QCAB-9.49ST-04	6,0 x 4,0mm	Polyamide 12	180°	10
QCAB-9.49ST-06	8,0 x 6,0mm	Polyamide 12	90°	10
QCAB-9.49RA-06	8,0 x 6,0mm	Polyamide 12	180°	10
QCAB-9.49ST-08	10,0 x 8,0mm	Polyamide 12	180°	10

Suitable Tubing

> Tube Size – 6,0x4,0mm Compliance – DIN 74324 designated PHLV - Pressure rating 15 bar

Part Number	Coil Size	Colour	Minimum Order Qty.
NF-0604-25	25 metres	Black	25 metres
NF-0604-100	100 metres	Black	100 metres
NF-0604-250	250 metres	Black	250 metres

> Tube Size – 8,0x6,0mm Compliance – DIN 74324 designated PHLV - Pressure rating 15 bar

Part Number	Coil Size	Colour	Minimum Order Qty.
NF-0806-25	25 metres	Black	25 metres
NF-0806-100	100 metres	Black	100 metres
NF-0806-250	250 metres	Black	250 metres

> Tube Size – 10,0x8,0mm Compliance – DIN 74324 designated PHLV - Pressure rating 15 bar

Part Number	Coil Size	Colour	Minimum Order Qty.
NF-1008-25	25 metres	Black	25 metres
NF-1008-100	100 metres	Black	100 metres
NF-1008-250	250 metres	Black	250 metres

Price on application depending on volume.
Working temperature -40°C to 70°C